

**Smart Cameras made in Germany**

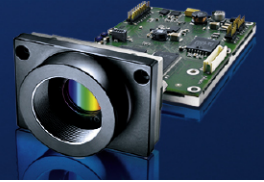

**Vision**®

**Components**

**The Smart Camera People**

**VC nano 3D**

**Operating Manual**

**Hardware specifications and special software functions  
of VC nano Smart Cameras**

Revision 1.8 – 14 Apr 2016

Document name: VC\_nano\_3D.pdf

© Vision Components GmbH Ettlingen, Germany

## Foreword and Disclaimer

This documentation has been prepared with most possible care. However Vision Components GmbH does not take any liability for possible errors. In the interest of progress, Vision Components GmbH reserves the right to perform technical changes without further notice.

Please notify [support@vision-components.com](mailto:support@vision-components.com) if you become aware of any errors in this manual or if a certain topic requires more detailed documentation.











This manual is intended for information of Vision Component's customers only. Any publication of this document or parts thereof requires written permission by Vision Components GmbH.

## Trademarks

Code Composer Studio and TMS320C6000, Windows XP, Total Commander, TeraTerm, Motorola are registered Trademarks. All trademarks are the property of their respective owners.

## Please also consult the following resources for further reference:

“[Knowledge Base / FAQ](#)” for a searchable data base of SW and HW questions / answers

Description	Title on Website	Download Area on VC website
 Quick start Manual for VC camera set up and programming	 Getting Started VC Smart Cameras with TI DSP	Service & Support > Download Center
 Schnellstart VC – deutsche Version of „Getting Started VC“.	 Schnellstart VC Smart Kameras	Service & Support > Download Center
Introduction to VC Smart Camera programming	 Programming Tutorial for VC20XX and VC40XX Cameras	Service & Support > Download Center
Demo programs and sample code used in the Programming Tutorial	 Tutorial Code	Service & Support > Download Center
VC40xx Hardware Manual	 VC40XX Smart Cameras Hardware Documentation	Service & Support > Download Center
VCRT Operation System Functions Manual	 VCRT 5.0 Software Manual	Service & Support > Download Center
VCRT Operation System TCP/IP Functions Manual	 VCRT 5.0 TCP/IP Manual	Service & Support > Download Center
VCLIB 2.0 /3.0 Image Processing Library Manual	 VCLIB 2.0/ 3.0 Software Manual	Service & Support > Download Center



- The Light bulb highlights hints and ideas that may be helpful for a development.



- This warning sign alerts of possible pitfalls to avoid. Please pay careful attention to sections marked with this sign.

**Author:** VC Support, <mailto:support@vision-comp.com>

# Table of Contents

<b>1 General Information</b>	<b>4</b>
<b>2 Technical Specifications</b>	<b>5</b>
2.1 General specifications VC nano 3D yr series	5
2.2 Measurement specifications	6
2.2.1 yr series	6
2.3 Framerate performance	7
2.3.1 yr series	<b>Fehler! Textmarke nicht definiert.</b>
<b>3 Sensor Interfaces</b>	<b>8</b>
3.1 LAN / Ethernet Interface	9
3.1.1 Pin Assignments LAN / Ethernet Interface	9
3.1.2 Available Accessories for LAN / Ethernet socket	9
3.2 Power Supply, I/O interface and trigger interface	10
3.2.1 Pin assignments Power Supply and IO Interface	10
3.2.2 Electrical specifications Camera Power Supply	10
3.2.3 Electrical Specifications digital PLC IO / trigger Interface	11
3.2.4 Available Accessories / Cables for Power Supply and IO Interface	13
3.3 VC nano 3D LED	14
<b>4 Accessories</b>	<b>15</b>
4.1 Order numbers of all VC nano 3D sensors	15
4.2 Order numbers of all available VC nano 3D Accessories	16
<b>5 Programming VC nano 3D Sensors</b>	<b>18</b>
5.1 General information	18
5.2 VC nano 3D Library	18
5.3 VC nano 3D Smart Shape Tool	18
<b>Appendix A: Dimensions VC nano 3D, front side, rack mounting</b>	<b>A</b>
<b>Appendix B: Dimensions VC nano 3D, rear side, side plate mounting</b>	<b>B</b>
<b>Appendix C: VC nano 3D field of view with 30° angle</b>	<b>C</b>
<b>Appendix D: VC nano 3D field of view with 45° angle</b>	<b>D</b>

## 1 General Information

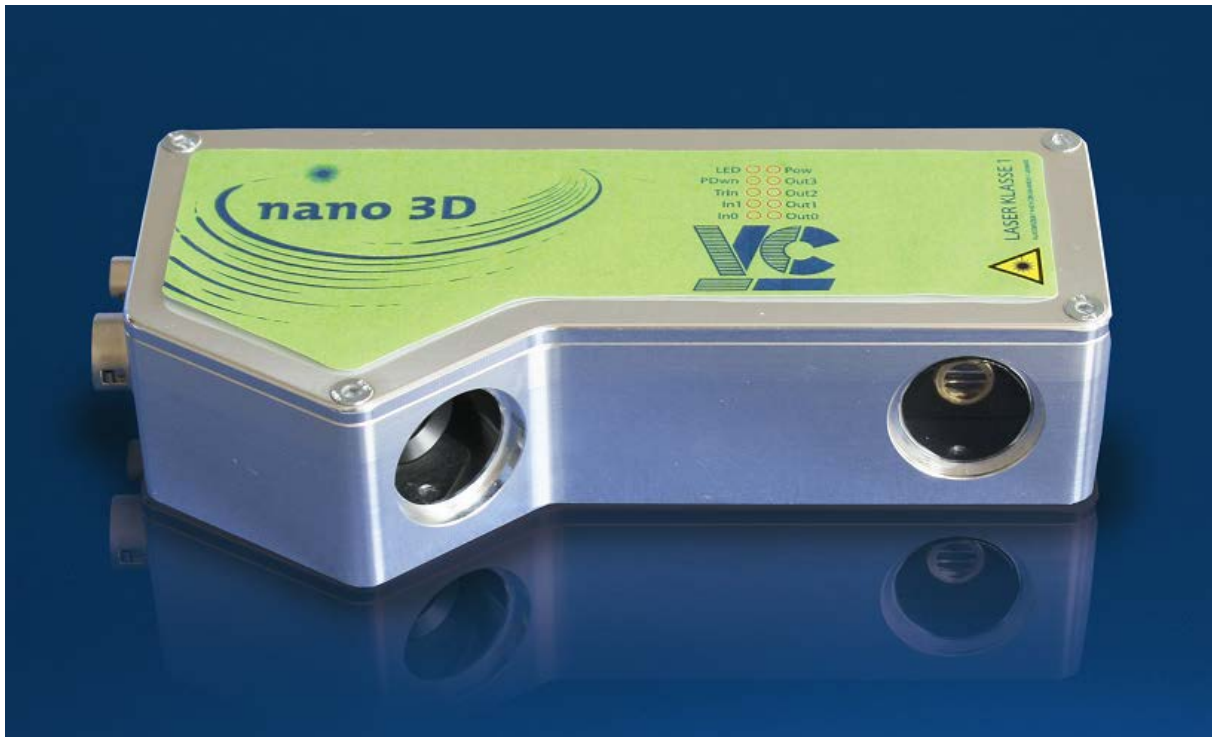

VC nano 3D Sensor

With the **VC nano 3D** we offer new options in the field of machine vision: intelligent 3D machine vision in a compact housing with full standalone data processing option.

The new VC nano 3D series unite all advantages of VC Smart Cameras: intelligent design and embedded computing in very compact housing. **Measuring merely 140 x 70 x 35 mm**, its housing includes an intelligent camera and a line laser which enables the real-time recording of images at a scan rate of up to 400 Hz according to the triangulation method.

The images can be analyzed by the DSP processor of the Smart Camera which has a computing power of 5,600 MIPS. Twelve different camera models cover a wide application range.

This makes the VC nano 3D the first intelligent 3D laser triangulation sensor in the world that offers the full functionality of smart cameras for internal data processing.

## 2 Technical Specifications

### 2.1 General specifications VC nano 3D yr series

Component / Feature	Specification
Laser	Class 1 laser line, wave length 660 nm, power 30 mW (100 mW class 2 laser available on demand)
CMOS Sensor:	1/1.8"
eff. no. of pixels:	1280(H) x 1024(V) (Wide VGA)
Pixel size:	5.3(H) x 5.3(V) $\mu\text{m}$
Chip size:	4.51(H) x 2.88(V) mm
High-speed shutter:	21 $\mu\text{s}$ + steps of 21 $\mu\text{s}$
Low-speed shutter:	up to 3 sec. adjustable integration time
Integration:	Global shutter
Picture taking:	program-controlled or external high speed trigger, full-frame (50 frames per second) & partial scanning, jitterfree acquisition
Scan rate:	Up to 1 kHz
Image Display	Via 100 Mbit Ethernet onto PC
Processor:	Texas Instruments TMS320DM6435 "Da Vinci" DSP 700 MHz, 5600MIPS
RAM:	128 Mbytes DDR2-RAM @ 333 MHz
Flash EPROM:	128 Mbytes flash EPROM (nonvolatile memory) for programs and data, in-system programmable
SD card:	Not available
Process interface:	2 inputs / 4 outputs, outputs 4x400 mA
Trigger:	1 picture trigger input, 1 flash trigger output, 24V / 200 mA
Ethernet interface:	10/100 Mbit
CE certification:	CE Certification from Vision Components
Storage Conditions	Temperature: -20 to 60 deg C, Max. humidity: 90%, non condensing.
Operating Conditions	Temperature: 0... +50 deg C, Max. humidity: 80%, non condensing.
Power Supply	24V +/-20% DC, max. 300 mA
Power Consumption	$\approx$ 2.6 W
Dimensions	140 x 70 x 35 mm, ca. 400 gr

## 2.2 Measurement specifications

### 2.2.1 yr series

VC nano 3D	yr830	y1230	yr1630	yr1645
Working distance [mm]	206	164	152	85
Measure range Dz +/- [mm]	130	70	50	20
Measure range Dx Min [mm]	75	60	45	35
Measure range Dx Max [mm]	270	125	85	50
Accuracy Z [ $\mu\text{m}$ ]	30 - 250	20 - 80	25 - 75	15 - 20
Accuracy X [ $\mu\text{m}$ ]	70 - 230	50 - 100	40 - 70	30 - 40

Example for **VC nano 3D yr830**:

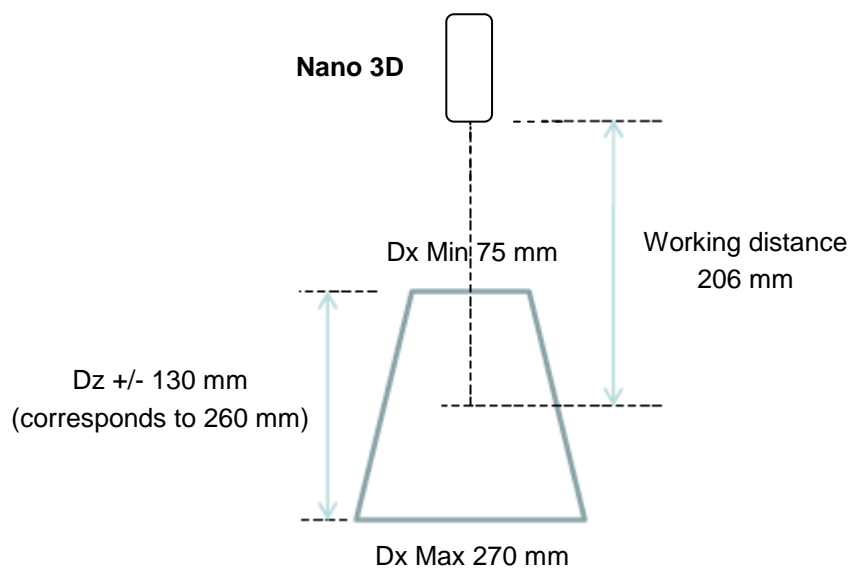

## 2.3 Framerate performance



The following diagram shows the reachable framerate according to the number of captured lines.

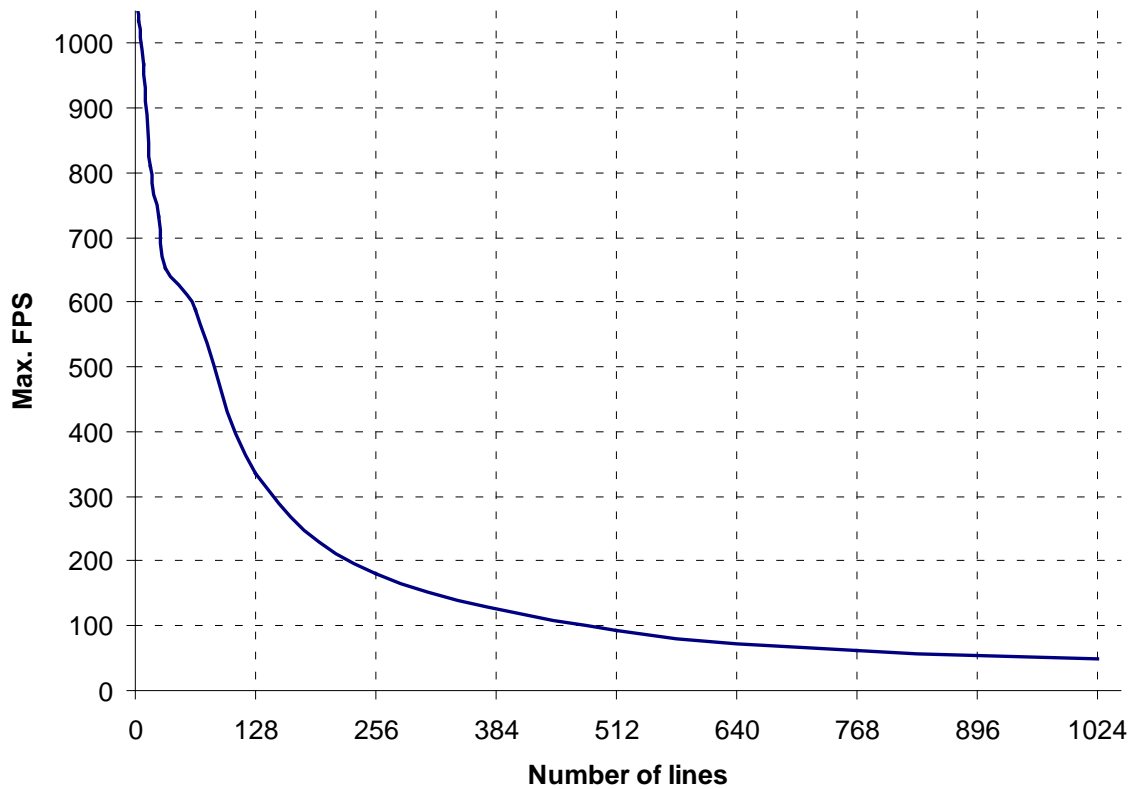

The following table gives some example values.

Resolution	Max. framerate (FPS)
1280 x 1024	50
1280 x 768	63
1280 x 512	93
1280 x 256	181
1280 x 128	336
1280 x 64	588
1280 x 32	652
1280 x 16	811
1280 x 8	968

### 3 Sensor Interfaces

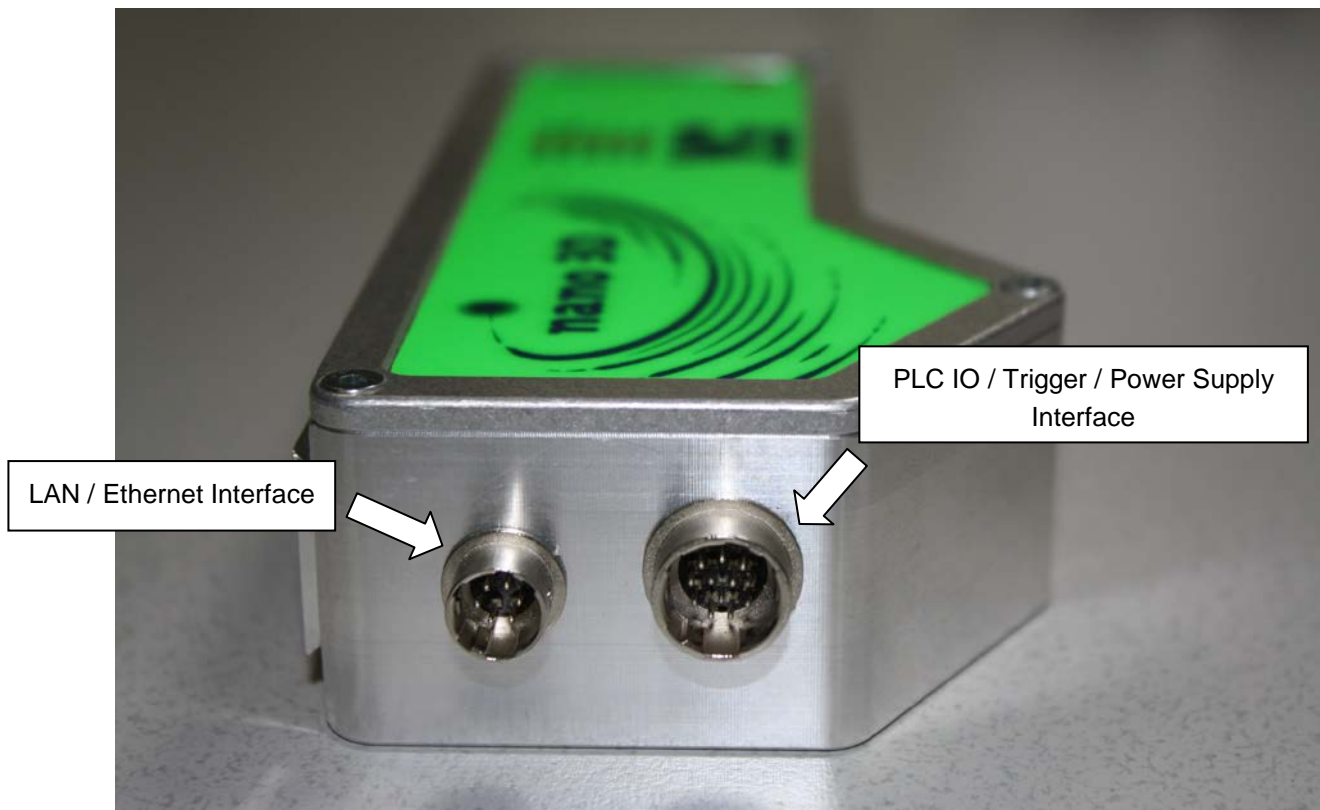

**The VC nano 3D sensor incorporate the following connector interfaces:**

- 1 : LAN / Ethernet interface
- 2: PLC IO, power supply and trigger interface

The pin assignments, electrical specifications as well as available accessories are shown for each interface connector in the following sections.



### 3.1 LAN / Ethernet Interface

#### 3.1.1 Pin Assignments LAN / Ethernet Interface

Signal	Pin
T+	2
T-	1
R+	6
R-	5
-	3
-	4

rear view camera socket:

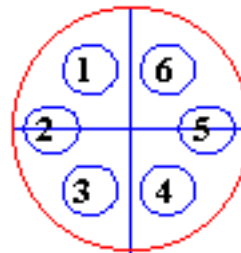

#### 3.1.2 Available Accessories for LAN / Ethernet socket

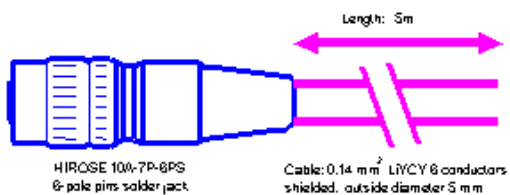

Signal	Pin (to cam.)	Pin (to PC)	Cable Color 20m patch cable	Cable Color 10m patch cable
T+	2	1	yellow	white/pink
T-	1	2	orange	pink
R+	6	3	white/green	white/green
R-	5	6	green	green
-	3	NC	-	-
-	4	NC	-	-

Refer to section 4.1 for a list of available cables with order numbers.

## 3.2 Power Supply, I/O interface and trigger interface

This connector includes the camera Power Supply, the digital PLC IOs and the trigger interface.

### 3.2.1 Pin assignments Power Supply and IO Interface

Pin	Signal	Calbe Colors
1*	24V PLC	red
2*	24V IN Cam	red / blue
3	GND IN com.	black.
4	INP 1	pink
5	OUT 3	yellow
6	OUT 2	green
7	OUT 1	brown
8	OUT 0	white
9*	24V PLC	grey / pink
10	Trigger OUT	purple
11	Trigger IN	blue
12	INP 0	grey

rear view camera socket:

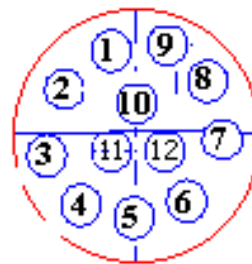

\* Pins 1, 2 and 9 are connected internally

### 3.2.2 Electrical specifications Camera Power Supply



With the **VC nano 3D** sensor the PLC supply contacts are internally connected with the camera power supply pin 2. In this case pin 1 and 9 require the same voltage level as the camera power supply pin 2. Refer to section 3.2.3 for details on the different PLC interface features.

	VC nano 3D
<b>Nominal Voltage</b>	24 V
<b>Absolute Voltage Limits</b>	24 V +/- 20%
<b>Maximum nominal Operating voltage and corresponding current (typical)</b>	24V 105 mA
<b>Nominal Power Consumption</b>	2.6 W

In general the camera power supply is regulated in the camera, so an unregulated power source is sufficient. However the absolute voltage levels specified above should never be exceeded.

In case of unstable power supply (voltage spikes or power interruptions) it is recommended to backup the power supply by a capacitor or a battery large enough to prevent power interruptions.

It is recommended to switch on the low voltage supply (24V) when booting the camera. Some 110/220V power supplies increase the output voltage too slow or drop the voltage under load at start – up which might cause the camera not to boot properly! A power supply able to supply a much higher than nominal boot current for a few milliseconds may be an alternative approach.

### 3.2.3 Electrical Specifications digital PLC IO / trigger Interface

The VC nano 3D sensor features digital inputs and outputs that allow e.g. direct input of light barriers signals or the control of pneumatic valves, as well as a trigger input and output.

Please observe the current and voltage ratings specified in the following sections.

The different interface features for these camera ranges are shown in the following table.

	VC nano 3D
<b>Separation of PLC/trigger output voltage</b> 	PLC outputs supply <b>not</b> separated from power supply
<b>PLC/trigger Input Voltage</b>	Identical with power supply voltage
<b>PLC/trigger Input Current (max)</b>	2.0mA @ 24V
<b>PLC/trigger Output Voltage</b>	Identical with power supply Voltage – internally connected
<b>PLC/trigger Output Current (max)</b>	4 x 400 mA Max total of all outputs: 1A*
<b>Max Current for 1 Power / PLC connector pin</b>	500 mA
<b>Power failure detection</b>	-

\* Outputs are fused with a resettable fuse with  $I_{trip} = 1A$  and  $I_{hold} = 500 mA$ .



When using the PLC/trigger outputs connect all camera supply and PLC supply pins (pin 1, pin 2 and pin 9) in order to limit the connector pin current.

The maximum combined current of all outputs should not exceed 1 A.

**Power consumption depending on supply voltage:**

Supply Voltage [V]	Current drawn [mA]	Power Consumption [W]
20	125	2.500
22	114	2.508
24	105	2.520
26	98	2.548
28	92	2.576
30	87	2.610

## 3.2.3.1 Connection of PLC/trigger inputs VC nano 3D

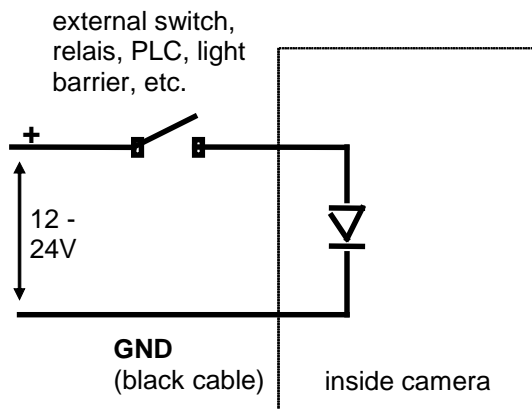

- **2 digital inputs**
- **1 trigger input**
- Operating Voltage 24 V
- Threshold Voltage 8V (input high for signals greater 8V)
- Maximum Voltage: 30V
- Reverse voltage protection
- Input Current 2mA @ 24V
- Signal debouncing hardware: none

## 3.2.3.2 Connection of PLC/trigger outputs VC nano 3D

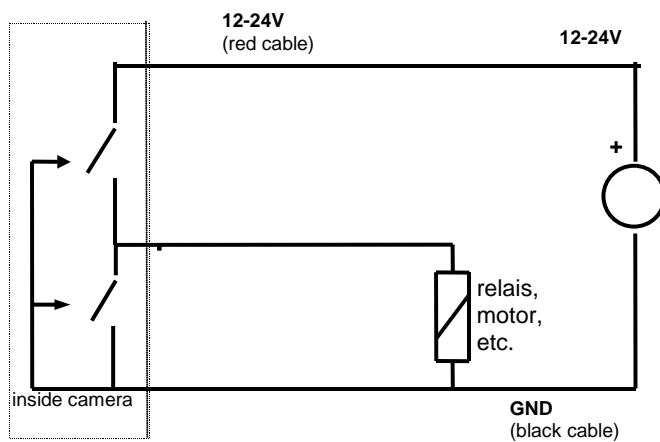

- **4 digital outputs**
- **1 trigger output**
- Operating Voltage 24 V
- current per output: 400 mA (total current all outputs < 1000 mA)
- Connect 24 V PLC and camera power supply pins 1, 2 and 9.
- bit = 1 output will switch positive voltage
- short-circuit and over-temperature protection (2A)
- push-pull outputs

## 3.2.4 Available Accessories / Cables for Power Supply and IO Interface

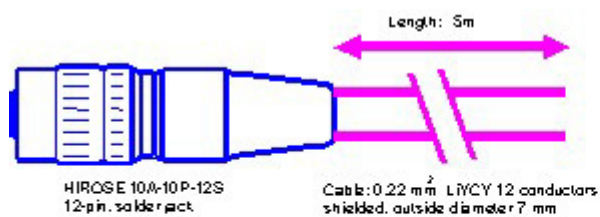

Signal	Pin No.	Cable color
OUT0	8	white
OUT1	7	brown
OUT2	6	green
OUT3	5	yellow
IN0	12	grey
IN1	4	pink
Trig IN	11	blue
Trig OUT	10	purple
24V IN Cam	2	red/blue
GND IN com.	3	black
24V PLC	1	red
24V PLC	9	grey / pink

Equipped on one end with a Hirose plug jack, length 5m, 10m or 25m  
Refer to section 4.1 for a list of available cables with order numbers.

### 3.3 VC nano 3D LED

The VC nano Smart Cameras features 10 LED providing status information on power supply, PLC I/Os and trigger input.

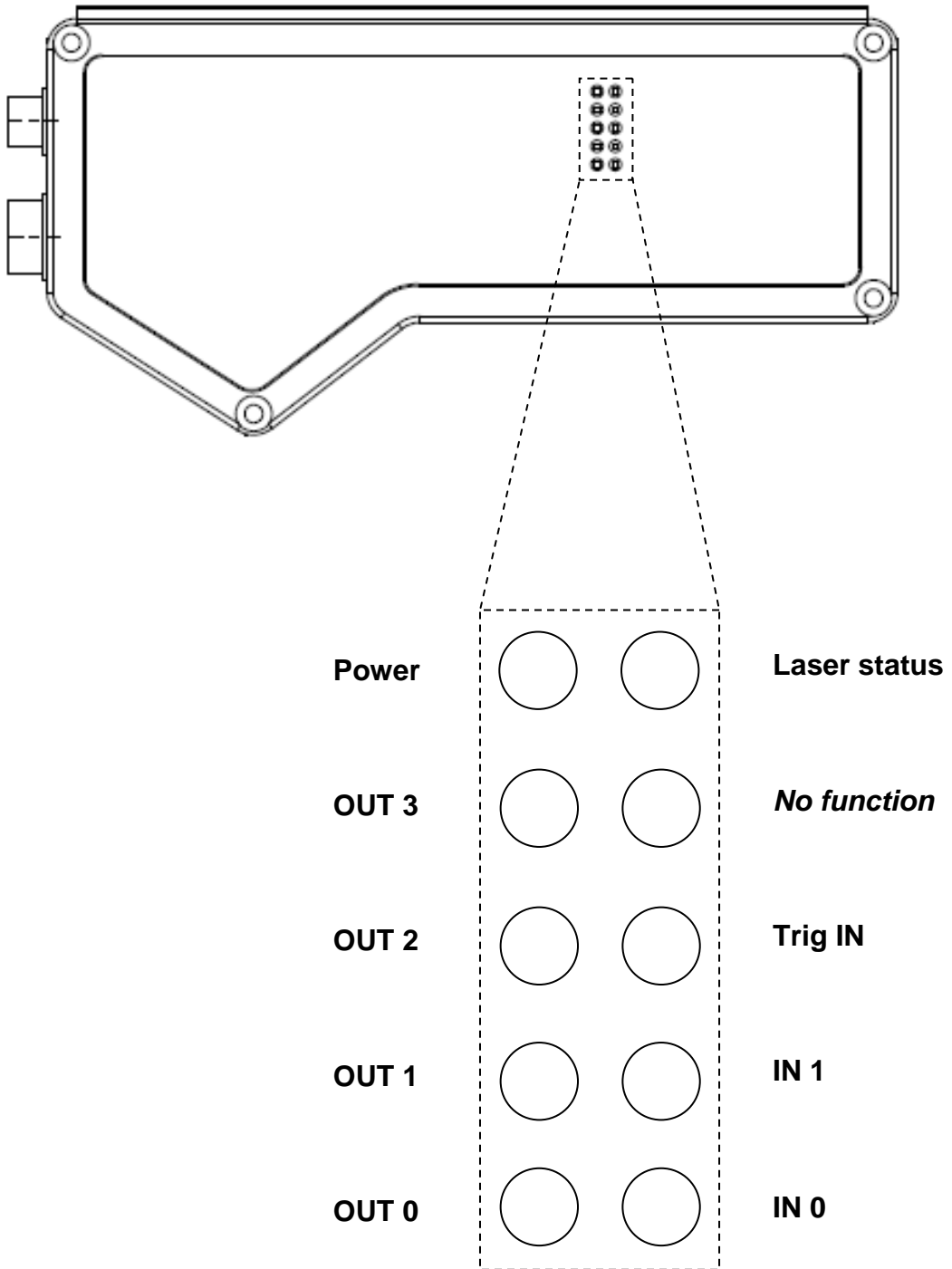

## 4 Accessories



### 4.1 Order numbers of all VC nano 3D sensors

Sensor	Order Number
VC nano 3D yr830	VK001228
VC nano 3D yr1230	VK001231
VC nano 3D yr1630	VK001239
VC nano 3D yr1645	VK001251

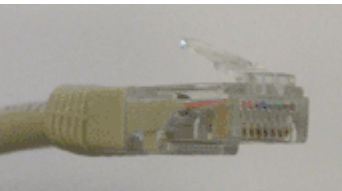

## 4.2 Order numbers of all available VC nano 3D Accessories

For interface cables and connectors available also consult the corresponding section in chapter 2.1 of this manual as well as the “*VC Smart Camera Accessories*” section – under the “Product” section on our website [www.vision-comp.com](http://www.vision-comp.com).

### Ethernet Cables (Refer to section 3.1.2):



Article Description	Order Number	Camera Connector	Second Connector
5m LAN-C6-Cable	VK000149	HRS connector female 6 pin 	RJ45 
10m LAN-C6-Cable	VK000150	HRS connector female 6 pin	RJ45
20m LAN-C6-Cable	VK000151	HRS connector female 6 pin	RJ45
Ethernet Cross Module	VK000156	 RJ45	RJ45 female socket

### Power Supply and IO Interface Cables (refer to section 6.3.5):

Article Description	Order Number	Camera Connector	Second Connector
5m Power / PLC-Cable C6	VK000008	HRS female 12 pin 	without connector 
10m Power / PLC-Cable C6	VK000114	HRS female 12 pin	without connector
25m Power / PLC-Cable C6	VK000161	HRS female 12 pin	without connector



**Further Accessories:**

Article Description	Order Number	Camera Connector
Power Adapter C6 24V, with 12 pins conn. 3m	VK000119	HRS connector female 12 pin 
<p>Power adapter for rail mounting, Input Voltage 100 - 240VAC 50/60 Hz, Output Voltage DC 24V +/-5%, max. 300 mA (7.5 W), Equipped with connecting clamps for AC input and 24V output, CE cert.</p> <p> Using this power supply with VC Base Cameras (VC4018 and VC4016) is only possible when booting by switching the 24V secondary side! 15W power supply needed if switching the mains supply!</p>	VK000036	

All cable lengths are 0.5m unless stated otherwise.

Please also refer to the VC website [www.vision-components.com](http://www.vision-components.com) for an up to date list of accessories.

## 5 Programming VC nano 3D Sensors

### 5.1 General information

Programming interfaces for VC nano 3D sensor are available under 2 forms:

- a C library from Vision Components, for direct programming on the camera
- a TCP/IP protocol for communicating with the sensor from e.g. a PC.

For programming with TCP/IP protocol a **Halcon Script** is provided (<http://www.vision-components.com/service-support/download-center/software/vc-nano-3d/>, customer access needed).

### 5.2 VC nano 3D Library

The VC nano 3D library can be downloaded here: <http://www.vision-components.com/service-support/download-center/software/vc-nano-3d/>. The documentation is included in the zip file.

### 5.3 VC nano 3D Smart Shape Tool

The VC nano 3D Smart Shape Tool consists of two parts:

- a camera program, which does the image processing and sends the results via TCP/IP using a special TCP/IP protocol
- a PC program, which gets the measurement results and can display both 2D and 3D images. The program also allows some parameter settings.

The source code of this tool is available on demand.

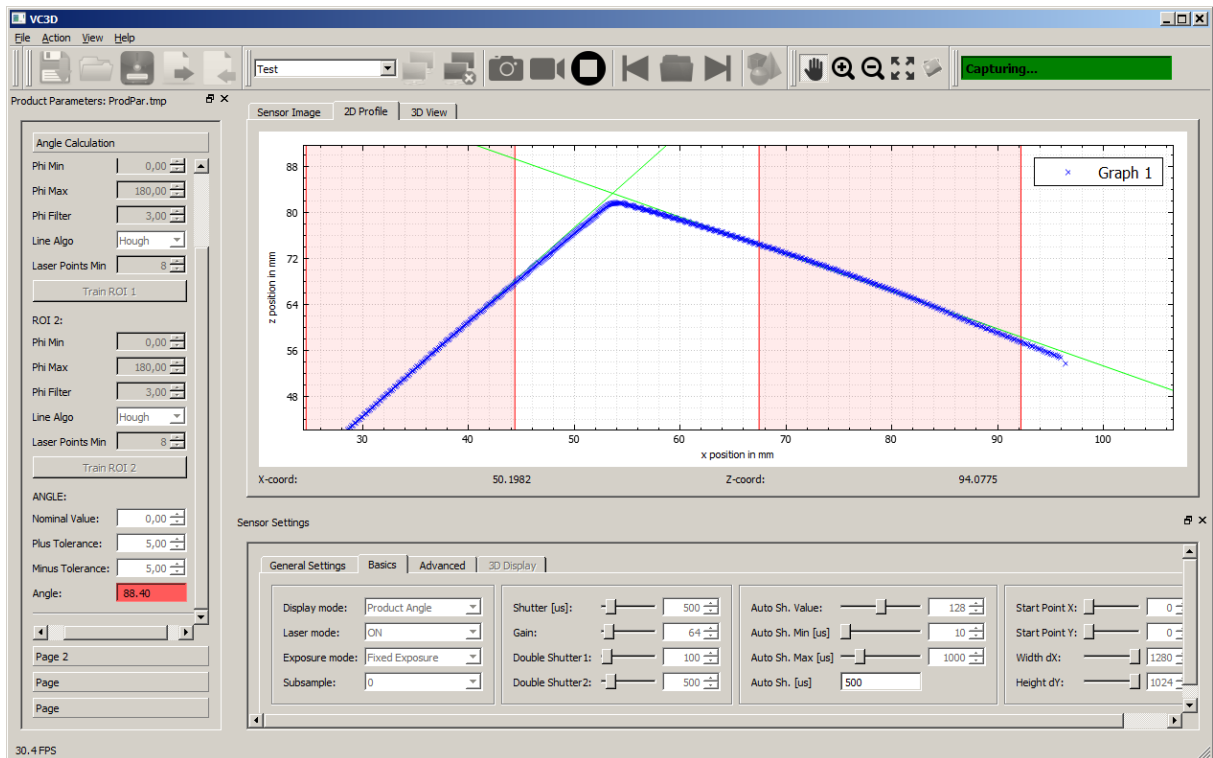

The current version of the VC nano 3D Tool is available in the download center of the VC website, under Software → VC nano 3D (<http://www.vision-components.com/en/service-support/download-center/software/vc-nano-3d/>).

Direct download-link: [http://files.vision-components.com/nano3D/VCSmartShape/VC3DSmartShape\\_V3.0.zip](http://files.vision-components.com/nano3D/VCSmartShape/VC3DSmartShape_V3.0.zip)

Documentation: [http://files.vision-components.com/nano3D/VCSmartShape/VC3D\\_SmartShape\\_Manual\\_2.8.pdf](http://files.vision-components.com/nano3D/VCSmartShape/VC3D_SmartShape_Manual_2.8.pdf)

## Appendix A: Dimensions VC nano 3D, front side, rack mounting

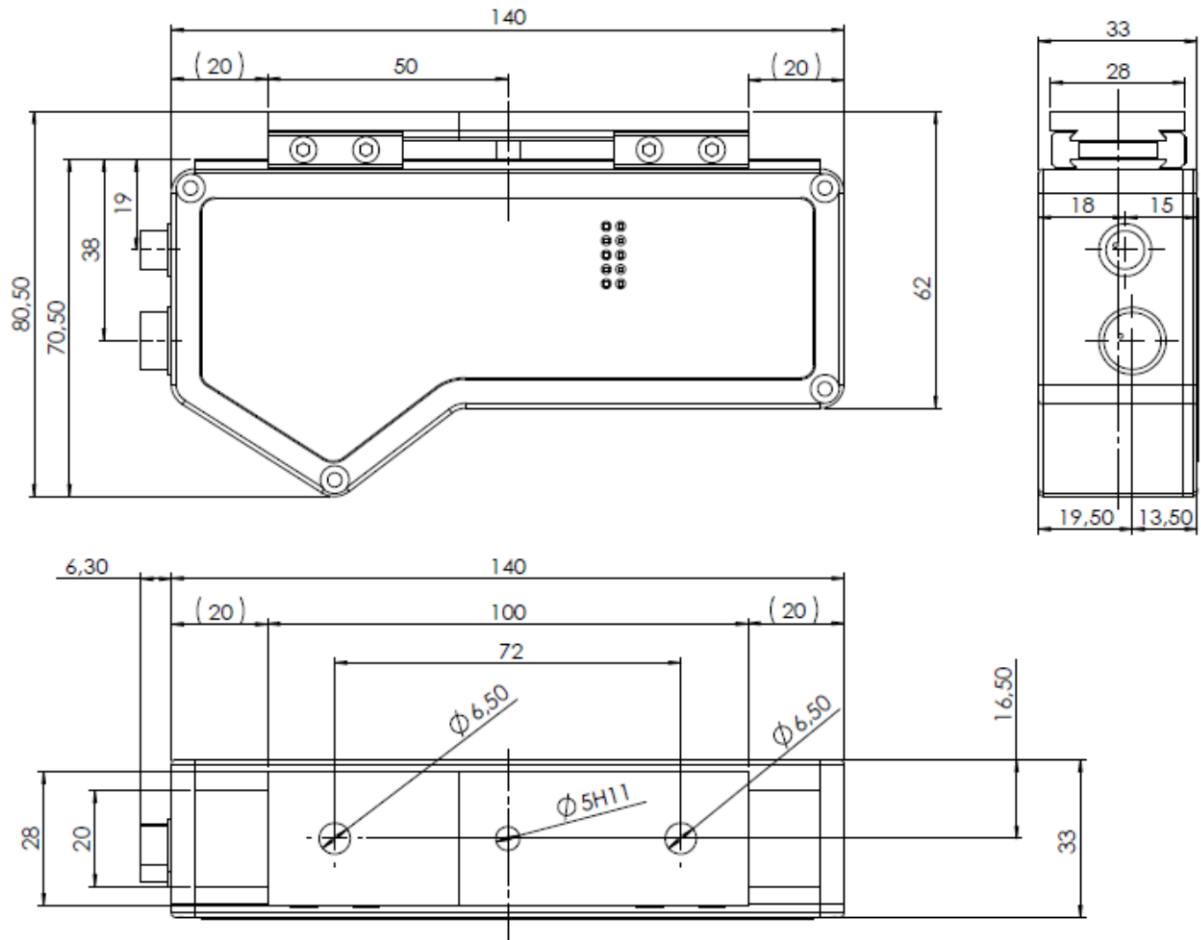

## Appendix B: Dimensions VC nano 3D, rear side, side plate mounting

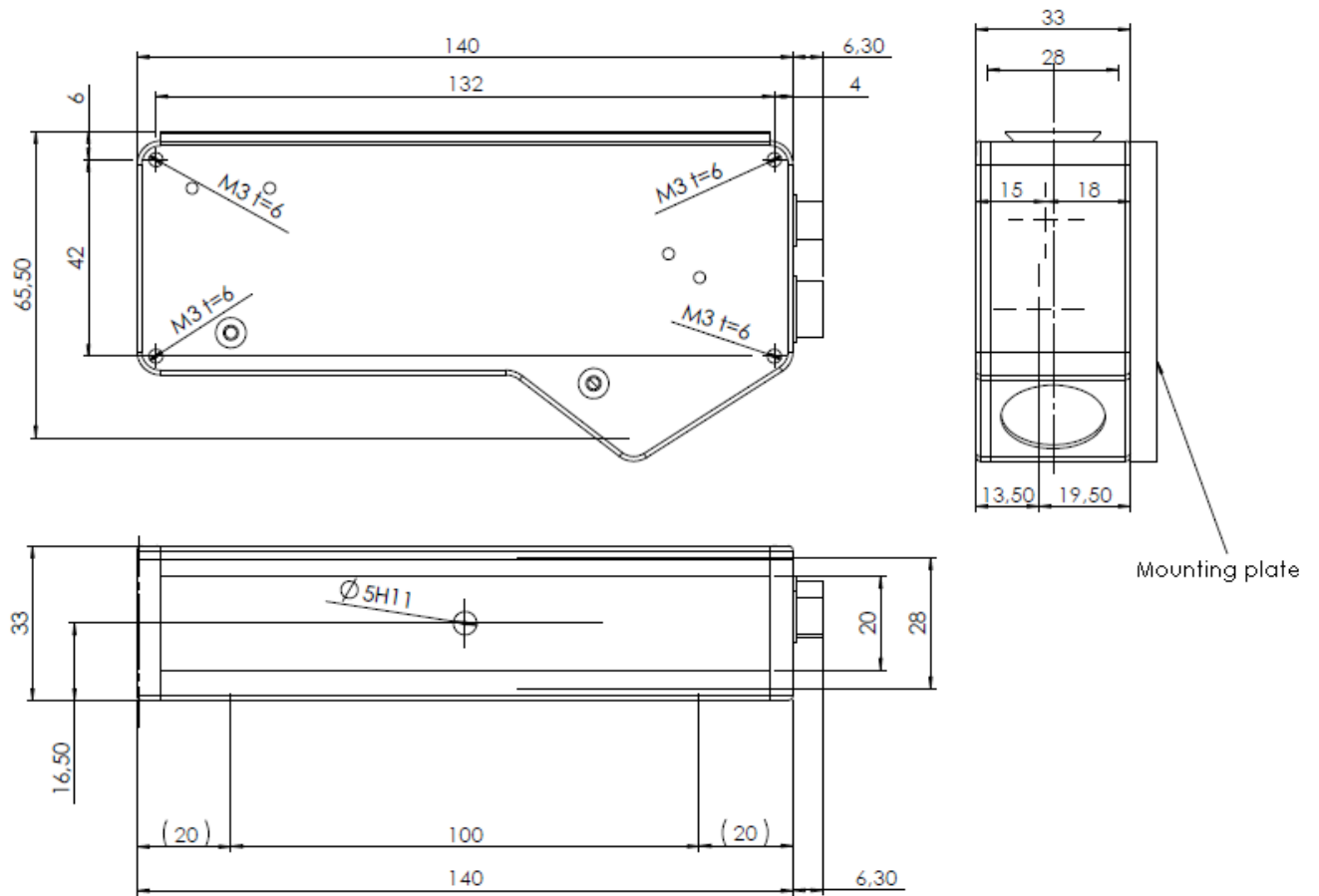

### Appendix C: VC nano 3D field of view with 30° angle

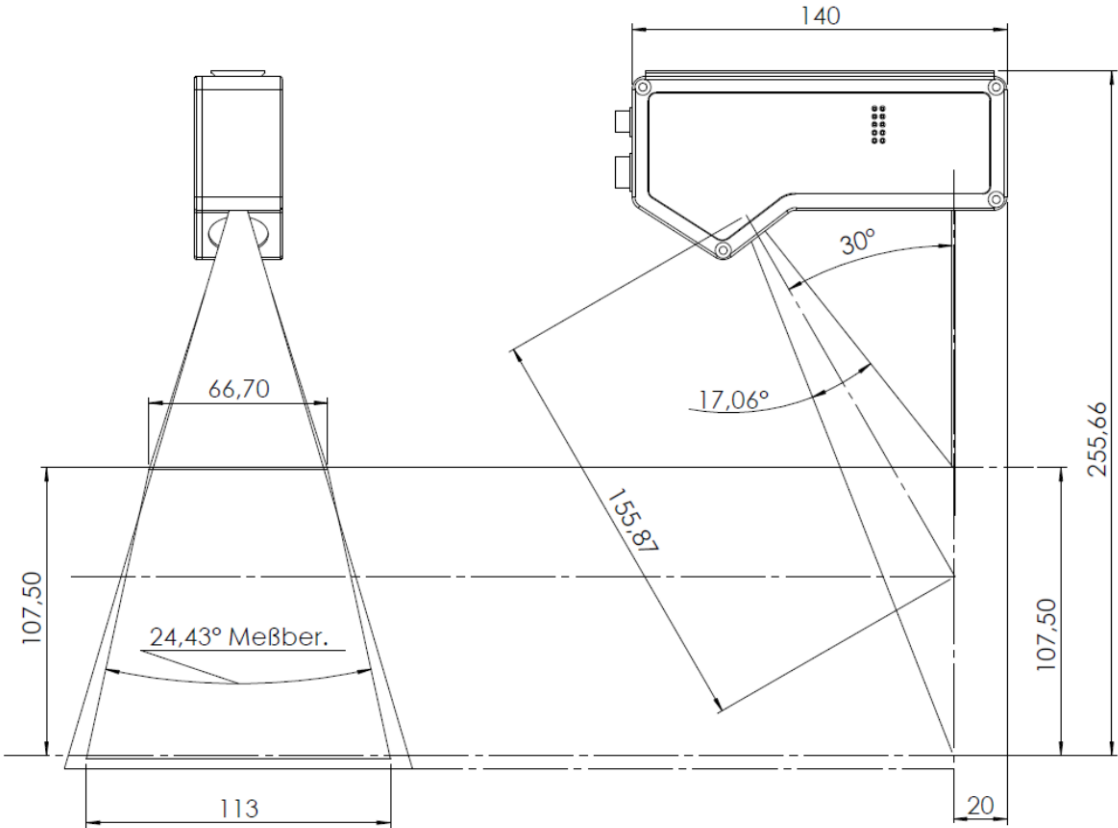

## Appendix D: VC nano 3D field of view with 45° angle

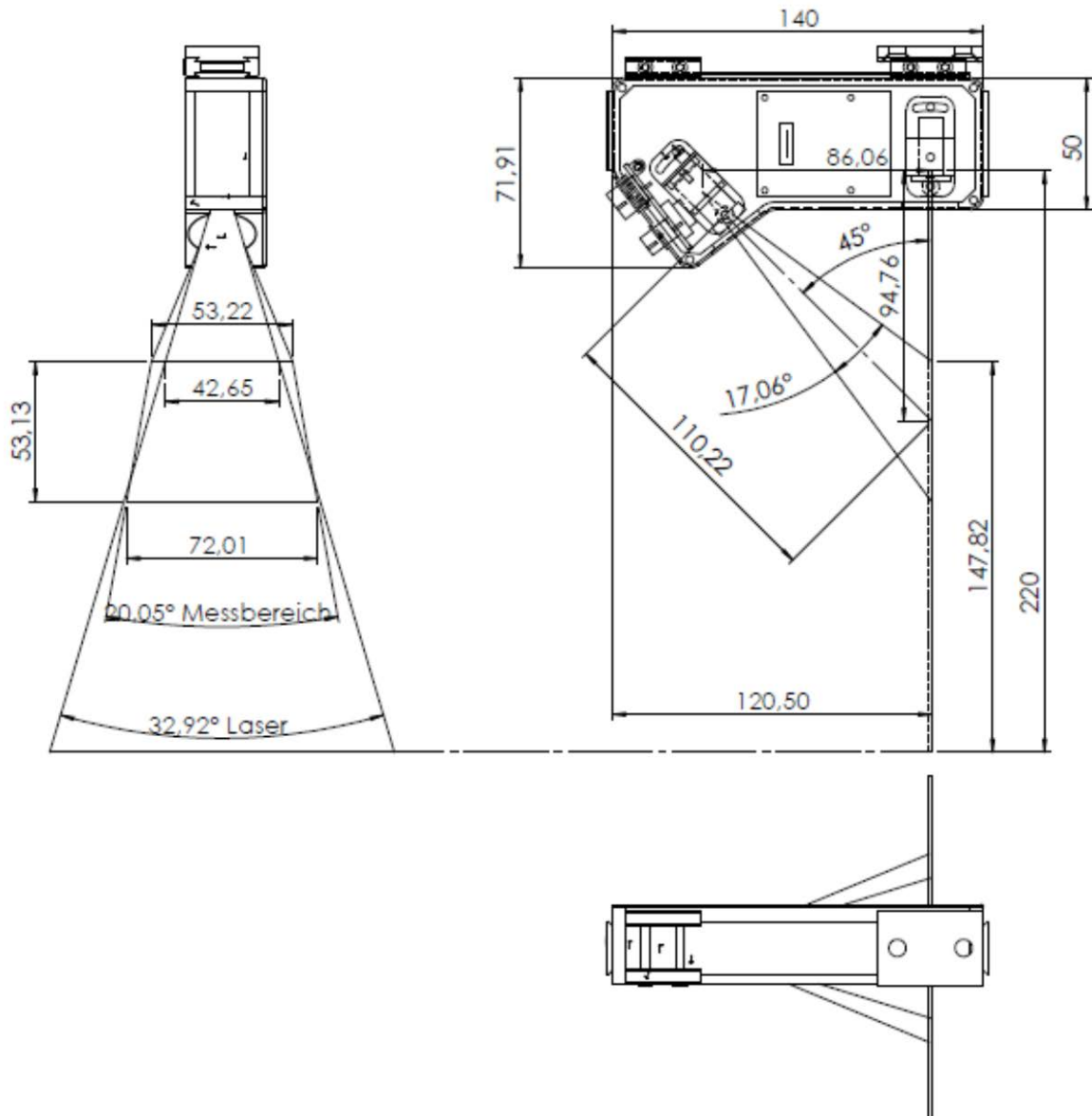

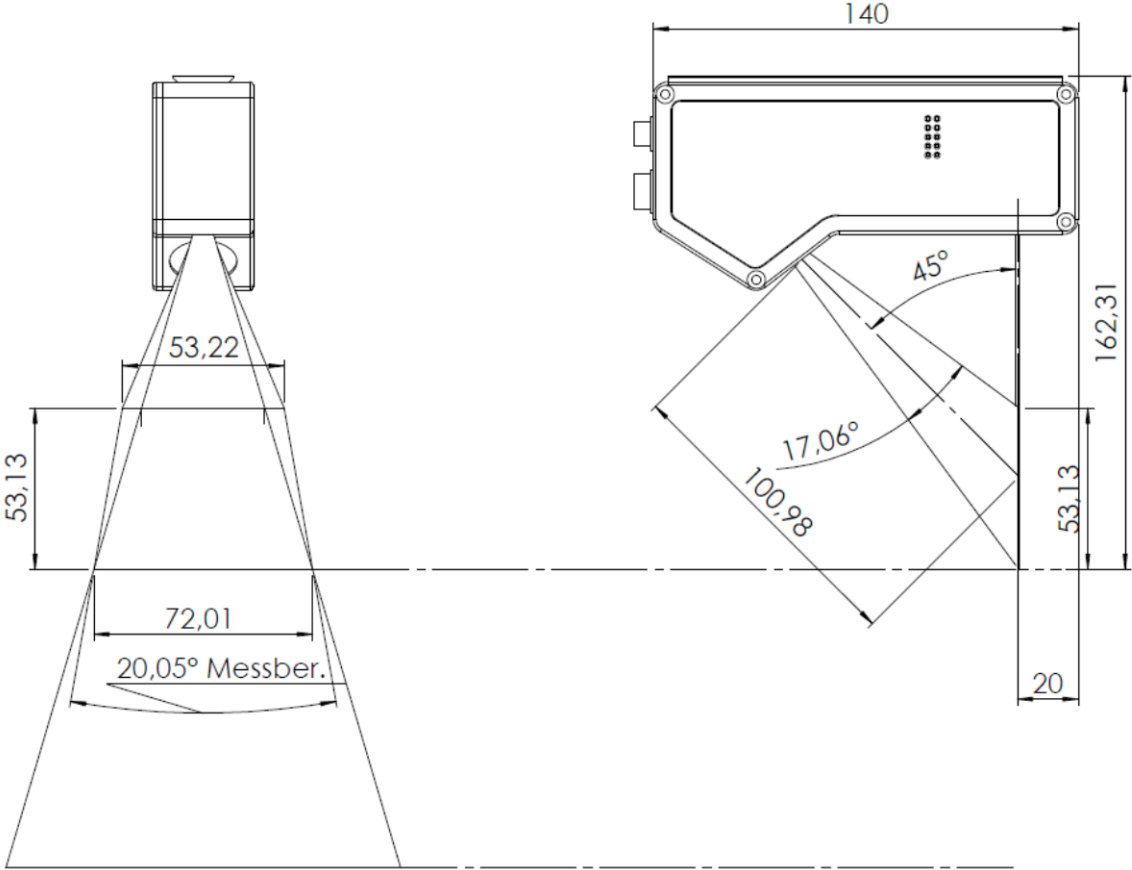



# Smart Cameras made in Germany



Visit the Vision Components site [www.vision-components.com](http://www.vision-components.com) for further information, documentation and software downloads:

Web Site Menu Links	Content
Home	Latest News from VC
Competences	VC Company Information VC Network
Solutions	Applications Industry
Products	Product Overview:
VC Smart Cameras	VC Base VC Professional VC Optimum VC Line Visicube VC Board Cameras VC Customized Accessories
VC Smart Camera Software	VCRT Operating System VCLIB Image Processing Library
VC Software Development Kit Ti:	
VC Special Libraries:	Color Lib Extension Lib VCOCR Text Recognition Library VC Smart Reader VC Smart Finder VC Solar Solution
News and Events	VC News Trade Show dates VC Seminars & Workshops
Service & Support:	
Contact	Contact Vision Components
Download Center	Download of:
Documentation (User Registration required)	<ul style="list-style-type: none"> <li>- Product Brochures</li> <li>- Camera Manuals</li> <li>- Getting Started</li> <li>- Programming Manuals</li> <li>- Training Manuals and Demo Code</li> <li>- Software Updates (VCRT &amp; Libs)</li> <li>- Demo Code</li> <li>- Software utilities</li> </ul>
Software (User- and SW License Registration required)	
Tech News	Tech News – new SW and Documentation
Knowledge Base / FAQ	FAQ Database with programming Examples and Demo Code
Return / Repair Service	Form for Allocation of Repair Numbers.
Loan systems	Info about VC loan cameras